

料号 Part NO.	品名 Parts Name	规格
----------------	------------------	----

41-F01-PC2253	推线式连接器	PC2253
---------------	--------	--------

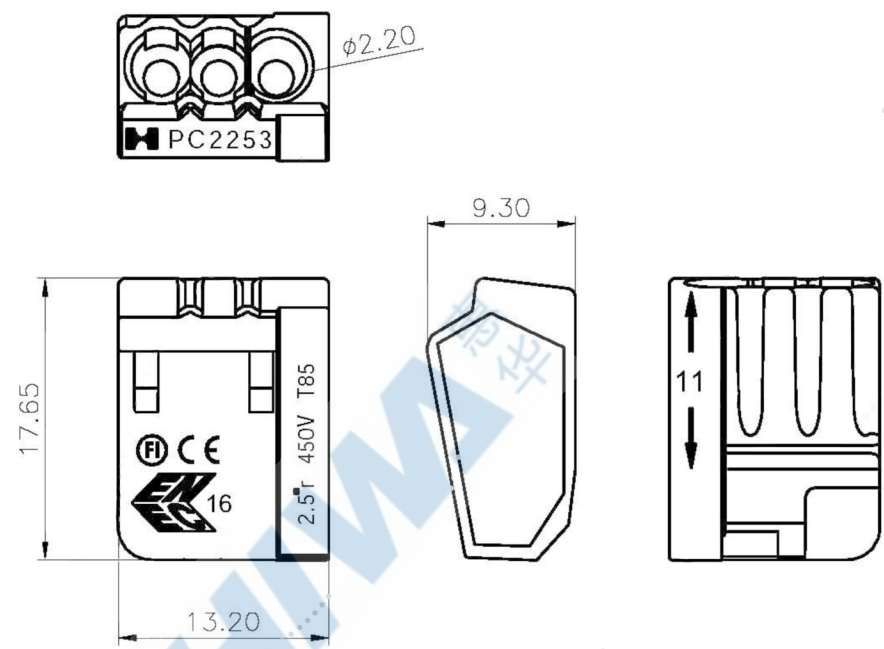

Housing Material: Polycarbonate(PC) and Polyamide 66(PA66), flame-retardant to UL 94V-0
 Current: 24A (IEC)
 Voltage: 450V (IEC)
 Working TEMP: T85 (IEC)
 Wire Range: 0.5-2.5mm² Sol/Rigid (IEC)
 Stripping Length: 11mm



未经许可不得修改和复印
 该知识产权属于技术质量部;

DIMENSION	TOLERANCES						DWG. BY	liu liang	UNIT	mm
.0 .00	±0.5						CHK. BY	sullivan	REV.	A
							APP. BY	wang zhiyan	DWG. NO.	HIWA/QR-JZ-41-F01-PC2253
FRIST ANGLE PROJ		A	NEW PART	sullivan	zy.wang	2019/05/110				
		LTR.	REVISION RECORD	DWG. BY	CHK. BY	DATE	苏州惠华电子科技有限公司			