

料号
Part NO.

品名
Parts Name

PC255

插式线接头 PC255

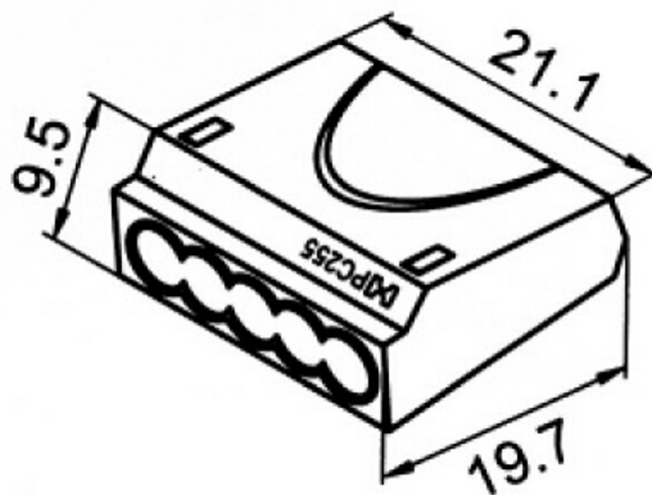

IEC: 24A, 450V, T110
 1-2.5mm², Rigid
 UL: 600V, 105°C
 #22-#12 AWG, SOL CU



未经许授权不得修改和复印
 该知识产权属于技术质量部;

DIMENSION	TOLERANCES						DWG. BY	<i>liu liang</i>	UNIT	mm
0.0 0.00	±0.20						CHK. BY	<i>sullivan</i>	REV.	A
							APP. BY	<i>wang zhiyan</i>	DWG. NO.	PC255
FRIST ANGLE PROJ 		A	NEW PART	<i>sullivan</i>	<i>zy. wang</i>	<i>2018-10-8</i>	苏州惠华电子科技有限公司			
LTR.	REVISION RECORD	DWG. BY	CHK. BY	DATE						