

料号 Part NO.	品名 Parts Name	A	B
34-TP2.6-7	塑胶铜柱 TP2.6-7	7.0	5.0

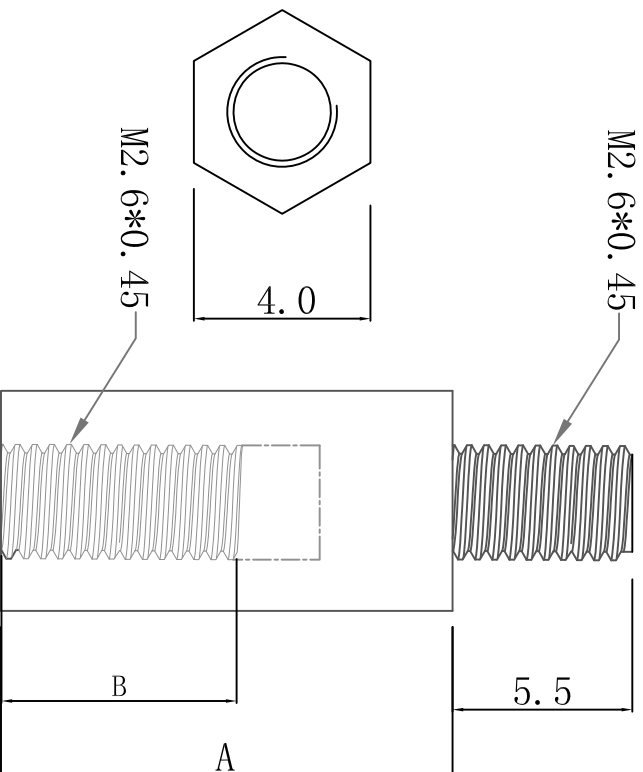

◆ MATERIAL: NYLON66 (UL) 94V-2
◆ UNIT: mm
用途: 做为PC板与机板间之固定, 六角型不滑动。



未经授权不得修改和复印
该知识产权属于技术质量部;

DIMENSION		TOLERANCES		FIRST ANGLE PROJ	
0.0		±0.5			
0.00					
A	NEW PART				
LTR.	REVISION RECORD	DWG. BY	CHK. BY	DATE	
		<i>oullian</i>	<i>zy wang</i>	<i>2011/28</i>	
DWG. BY	CHK. BY	APP. BY	DWG. NO.	UNIT	mm
<i>Lin Liang</i>	<i>oullian</i>	<i>wang ziyuan</i>	HIMA/QR-JZ-34-TP2.6-7	REV.	A
HIMA 惠华		苏州惠华电子科技有限公司			